



wentor®
Importer urządzeń grzewczych



**CENNIK
KATALOG
2017**

Pionier W6



1350 zł brutto



Moc nominalna [kW]	13,7	Waga [kg]	95
Szerokość [mm]	685	Śred. wylotu spalin [mm]	180
Wysokość [mm]	515	Sprawność [%]	72,9
Głębokość [mm]	380		

Standard W2



1900 zł brutto

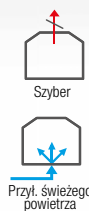

Moc nominalna [kW]	14,4	Waga [kg]	135
Szerokość [mm]	630	Śred. wylotu spalin [mm]	200
Wysokość [mm]	530	Sprawność [%]	76,9
Głębokość [mm]	435		

Standard W1



2020 zł brutto

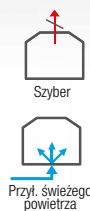

Moc nominalna [kW]	18	Waga [kg]	153
Szerokość [mm]	680	Śred. wylotu spalin [mm]	200
Wysokość [mm]	530	Sprawność [%]	73,9
Głębokość [mm]	435		

Retro W4



1937 zł brutto

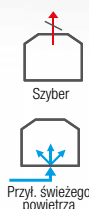

Moc nominalna [kW]	14,5	Waga [kg]	141
Szerokość [mm]	700	Śred. wylotu spalin [mm]	200
Wysokość [mm]	540	Sprawność [%]	72
Głębokość [mm]	420		

Retro W4P prawy



2130 zł brutto

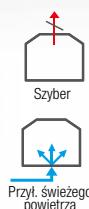

Moc nominalna [kW]	14,5	Waga [kg]	141
Szerokość [mm]	700	Śred. wylotu spalin [mm]	200
Wysokość [mm]	540	Sprawność [%]	72
Głębokość [mm]	420		

Retro W4L lewy



2130 zł brutto

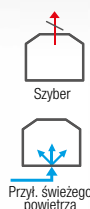

Moc nominalna [kW]	14,5	Waga [kg]	141
Szerokość [mm]	700	Śred. wylotu spalin [mm]	200
Wysokość [mm]	540	Sprawność [%]	72
Głębokość [mm]	420		

Retro W4PL prawy/lewy



2325 zł brutto

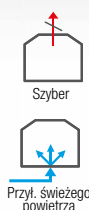

Moc nominalna [kW]	14,5	Waga [kg]	141
Szerokość [mm]	700	Śred. wylotu spalin [mm]	200
Wysokość [mm]	540	Sprawność [%]	72
Głębokość [mm]	420		

Retro W3



2200 zł brutto

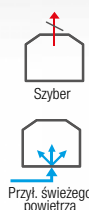

Moc nominalna [kW]	16,7	Waga [kg]	143
Szerokość [mm]	700	Śred. wylotu spalin [mm]	200
Wysokość [mm]	540	Sprawność [%]	74,1
Głębokość [mm]	420		

Retro W3P prawy



2410 zł brutto

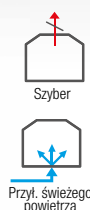

Moc nominalna [kW]	16,7	Waga [kg]	143
Szerokość [mm]	700	Śred. wylotu spalin [mm]	200
Wysokość [mm]	540	Sprawność [%]	74,1
Głębokość [mm]	420		

Retro W3L lewy



2410 zł brutto

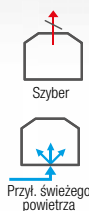

Moc nominalna [kW]	16,7	Waga [kg]	143
Szerokość [mm]	700	Śred. wylotu spalin [mm]	200
Wysokość [mm]	540	Sprawność [%]	74,1
Głębokość [mm]	420		

Retro W3PL prawy/lewy



2600 zł brutto

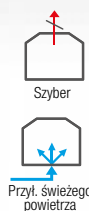

Moc nominalna [kW]	16,7	Waga [kg]	143
Szerokość [mm]	700	Śred. wylotu spalin [mm]	200
Wysokość [mm]	540	Sprawność [%]	74,1
Głębokość [mm]	420		

Modern W11

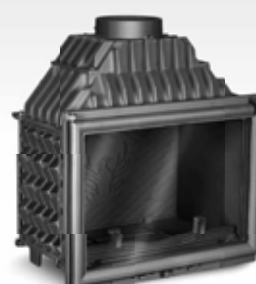

2200 zł brutto

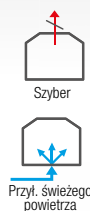

Moc nominalna [kW]	18,1	Waga [kg]	150
Szerokość [mm]	680	Śred. wylotu spalin [mm]	200
Wysokość [mm]	530	Sprawność [%]	70,5
Głębokość [mm]	435		

Pryzmat W5

3350 zł brutto

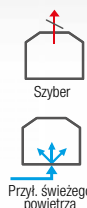

Moc nominalna [kW]	14,4	Waga [kg]	135
Szerokość [mm]	675	Śred. wylotu spalin [mm]	200
Wysokość [mm]	565	Sprawność [%]	70,4
Głębokość [mm]	445		

Panorama W10

3450 zł brutto



Moc nominalna [kW]	16,2	Waga [kg]	160
Szerokość [mm]	675	Śred. wylotu spalin [mm]	200
Wysokość [mm]	570	Sprawność [%]	74,2
Głębokość [mm]	490		

Smok W8

3350 zł brutto

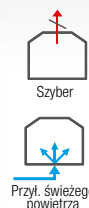

Moc nominalna [kW]	19,7	Waga [kg]	230
Szerokość [mm]	795	Śred. wylotu spalin [mm]	200
Wysokość [mm]	620	Sprawność [%]	73,2
Głębokość [mm]	480		

Grand W15

2040 zł brutto



Moc nominalna [kW]	12	Waga [kg]	121
Szerokość [mm]	740	Śred. wylotu spalin [mm]	180
Wysokość [mm]	435	Sprawność [%]	71,7
Głębokość [mm]	425		

Flat W12 złoto

3900 zł brutto



Moc nominalna [kW]	19,4	Waga [kg]	185
Szerokość [mm]	880	Śred. wylotu spalin [mm]	200
Wysokość [mm]	510	Sprawność [%]	71,9
Głębokość [mm]	465		

Flat W12 chrom

3900 zł brutto



Moc nominalna [kW]	19,4	Waga [kg]	185
Szerokość [mm]	880	Śred. wylotu spalin [mm]	200
Wysokość [mm]	510	Sprawność [%]	71,9
Głębokość [mm]	465		

WKŁADY
KOMINKOWE
z płaszczem
wodnym

Standard W1C0

3500 zł brutto



Moc nominalna [kW]	18,7	Waga [kg]	167
Szerokość [mm]	680	Śred. wylotu spalin [mm]	180
Wysokość [mm]	530	Sprawność [%]	78,5
Głębokość [mm]	460	Pojemność wodna [l]	20

Modern W11C0

3650 zł brutto



Moc nominalna [kW]	18,0	Waga [kg]	164
Szerokość [mm]	680	Śred. wylotu spalin [mm]	180
Wysokość [mm]	530	Sprawność [%]	78,5
Głębokość [mm]	460	Pojemność wodna [l]	20

Retro W3C0

3800 zł brutto



Moc nominalna [kW]	18,3	Waga [kg]	159
Szerokość [mm]	725	Śred. wylotu spalin [mm]	180
Wysokość [mm]	540	Sprawność [%]	74,7
Głębokość [mm]	430	Pojemność wodna [l]	45

Smok W7C0

4200 zł brutto



Moc nominalna [kW]	25,3	Waga [kg]	200
Szerokość [mm]	795	Śred. wylotu spalin [mm]	200
Wysokość [mm]	620	Sprawność [%]	75,8
Głębokość [mm]	525	Pojemność wodna [l]	57

Panorama W10C0

4150 zł brutto



Moc nominalna [kW]	19,9	Waga [kg]	154
Szerokość [mm]	675	Śred. wylotu spalin [mm]	200
Wysokość [mm]	570	Sprawność [%]	73,7
Głębokość [mm]	520	Pojemność wodna [l]	42

P2



2590 zł brutto

Moc nom. [kW]	10	Szerokość [mm]	645
Waga [kg]	185	Wysokość [mm]	600
Śred. wylotu spalin	180	Głębokość [mm]	530

P3



1450 zł brutto

Moc nom. [kW]	6	Szerokość [mm]	465
Waga [kg]	90	Wysokość [mm]	625
Śred. wylotu spalin	150	Głębokość [mm]	450

P6



1450 zł brutto

Moc nom. [kW]	6	Szerokość [mm]	430
Waga [kg]	60	Wysokość [mm]	565
Śred. wylotu spalin	150	Głębokość [mm]	387

P10



1550 zł brutto

Moc nom. [kW]	9.6	Szerokość [mm]	490
Waga [kg]	77	Wysokość [mm]	615
Śred. wylotu spalin	150	Głębokość [mm]	480

AKCESORIA KOMINKOWE

Nóżki regulowane

Nóżki umożliwiają równe i precyzyjne ustawienie wkładu kominkowego.



W1-W12

179 zł brutto



W15-W16

179 zł brutto



W17

179 zł brutto

Technologia oczyszczania szyby Smart Clean

W16-W17 premium **160 zł brutto**

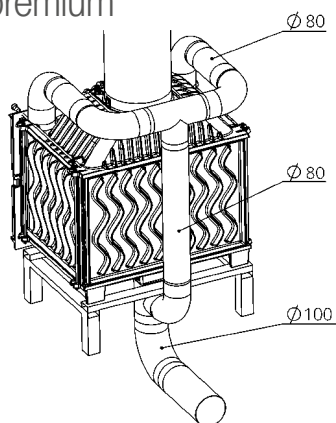

Doloty powietrza Ø 100 mm



W1-W12

170 zł brutto



W16-W17

170 zł brutto



W15

170 zł brutto

Grand W16 premium

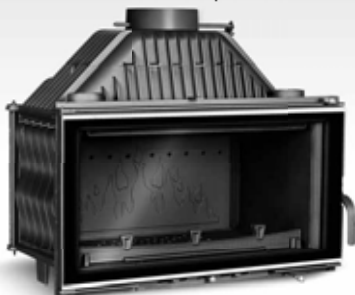

2570 zł brutto



Moc nominalna [kW]	14,7	Waga [kg]	125
Szerokość [mm]	740	Średnica wylotu spalin [mm]	180
Wysokość [mm]	435	Sprawność [%]	74,1
Głębokość [mm]	425		

Corner W16 L/P premium



3570 zł brutto



Moc nominalna [kW]	14,7	Waga [kg]	135
Szerokość [mm]	805	Średnica wylotu spalin [mm]	180
Wysokość [mm]	447	Sprawność [%]	74,1
Głębokość [mm]	453		

Kompakt W17 premium glass



2390 zł brutto



Moc nominalna [kW]	16	Waga [kg]	158
Szerokość [mm]	660	Średnica wylotu spalin [mm]	200
Wysokość [mm]	515	Sprawność [%]	70
Głębokość [mm]	500		

Corner W17 L/P glass



4250 zł brutto

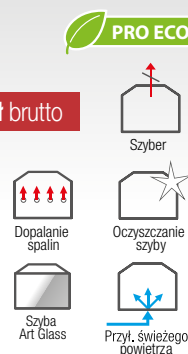

Moc nominalna [kW]	16	Waga [kg]	150
Szerokość [mm]	690	Średnica wylotu spalin [mm]	200
Wysokość [mm]	516	Sprawność [%]	70
Głębokość [mm]	492		

Kompakt W17 premium



1999 zł brutto



Moc nominalna [kW]	16	Waga [kg]	158
Szerokość [mm]	660	Średnica wylotu spalin [mm]	200
Wysokość [mm]	515	Sprawność [%]	70
Głębokość [mm]	500		

Corner W17 L/P



3900 zł brutto



Moc nominalna [kW]	16	Waga [kg]	150
Szerokość [mm]	690	Średnica wylotu spalin [mm]	200
Wysokość [mm]	516	Sprawność [%]	70
Głębokość [mm]	492		

Kompakt W17 14kW premium



1800 zł brutto



Moc nominalna [kW]	14	Waga [kg]	125
Szerokość [mm]	600	Średnica wylotu spalin [mm]	200
Wysokość [mm]	492	Sprawność [%]	70
Głębokość [mm]	455		

Kompakt W17 14kW premium glass



2200 zł brutto



Moc nominalna [kW]	14	Waga [kg]	125
Szerokość [mm]	600	Średnica wylotu spalin [mm]	200
Wysokość [mm]	492	Sprawność [%]	70
Głębokość [mm]	455		

Wyłączny przedstawiciel Kawmet w Polsce:



wentor®
Importer urządzeń grzewczych

Wentor

ul. Słowackiego
68-200 Żary, woj. lubuskie
biuro@wentor.pl
☎ 68 363 81 88
www.wentor.pl

Dystrybutor:

